

NOWE ATRAKCYJNE
CENY

TECEdrainline
TECEdrain

Odwodnienia liniowe i punktowe – nowe przestrzenie w łazience



Cennik
07 | 2011

Obowiązujący od 01 lipca 2011.

TECE □

Inteligentna technika domowa

Rynna prosta

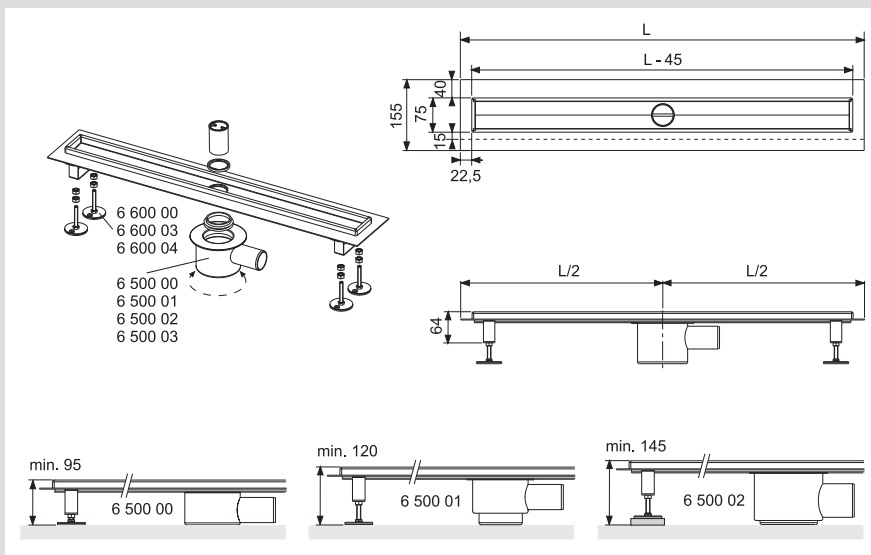

OZ - Opakowanie zbiorcze
Ceny netto (bez VAT).

	Rynna odpływowa - prosta z kolnierzem	Rozmiar	Nr kat.	OZ/szt.	ZŁ/szt.
		Długość:			
		700 mm	6 007 00	1	490,00
		800 mm	6 008 00	1	590,00
		900 mm	6 009 00	1	690,00
		1000 mm	6 010 00	1	750,00
		1200 mm	6 012 00	1	830,00
1500 mm	6 015 00	1	920,00**		

Rynna kątowa

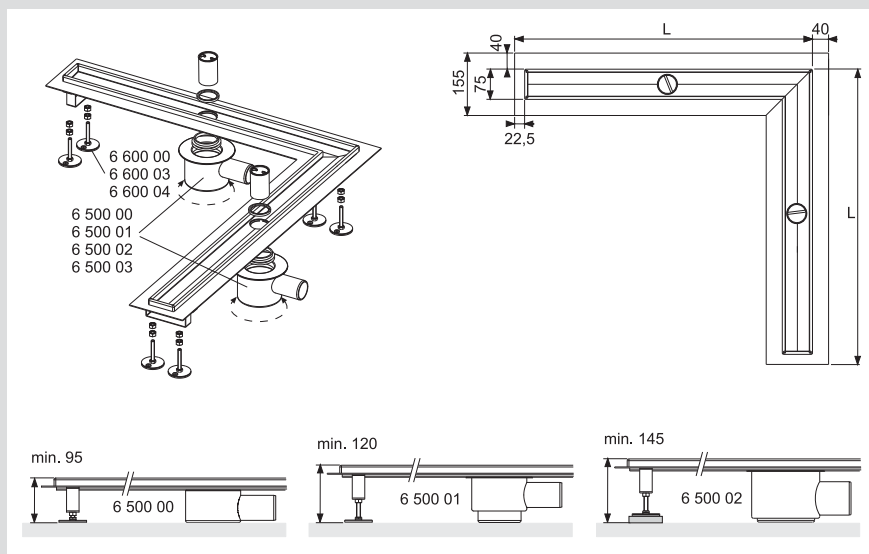

OZ - Opakowanie zbiorcze
Ceny netto (bez VAT).

	Rynna odpływowa - kątowa	Rozmiar	Nr kat.	OZ/szt.	ZŁ/szt.
		Długość:			
		900 mm	6 109 00	1	1550,00**
		1000 mm	6 110 00	1	1640,00**
		1200 mm	6 112 00	1	1790,00**
		1500 mm	6 115 00	1	1890,00**

Kolano odpływowe z syfonem

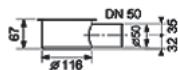

Nr. kat. 6 500 00

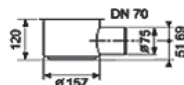

Nr. kat. 6 500 02

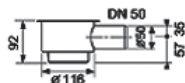



Nr. kat. 6 500 01



Nr. kat. 6 500 03

OZ - Opakowanie zbiorcze
Ceny netto (bez VAT).

	Kolano odpływowe z syfonem	Rozmiar		Nr kat.	OZ/szt.	Zł/szt.
		95 mm	0,70 l/s			
		120 mm	0,80 l/s	6 500 01	1	69,00
		145 mm	1,20 l/s	6 500 02	1	95,00
	Kolano odpływowe z syfonem pionowym	Rozmiar		Nr kat.	OZ/szt.	Zł/szt.
			1,30 l/s			
				6 500 03	1	95,00

UWAGA – dla rusztów kątowych należy zamawiać 2 kolana odpływowe

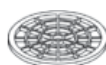
	NOWOŚĆ Sitko do założenia w rynnie TECEdrainline. Zabezpiecza przed zanieczyszczeniem syfonu	Rozmiar		Nr kat.	OZ/szt.	Zł/szt.
				6 600 05	1	35,00

Stopki montażowe

	Stopki montażowe z izolacją dźwiękową, komplet 4 szt.	Rozmiar		Nr kat.	OZ/kpl.	Zł/kpl.
		92 - 139 mm	137 - 184 mm			
				6 600 03	1	49,00
				6 600 04	1	55,00

Ruszt prosty

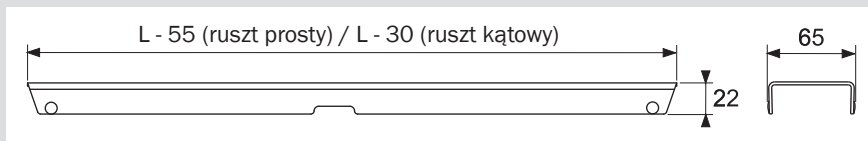

OZ - Opakowanie zbiorcze
Ceny netto (bez VAT).

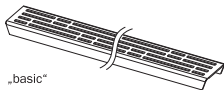

	Rusztz prostz ze szkła	Rozmiar	Nr kat.	OZ/szt.	Zł/szt.
	szkło zielone	700 mm	6 007 90	1	891,00**
		800 mm	6 008 90	1	981,00**
		900 mm	6 009 90	1	1062,00**
		1000 mm	6 010 90	1	1143,00**
		1200 mm	6 012 90	1	1242,00**
		1500 mm	6 015 90	1	1341,00**
	szkło białe	700 mm	6 007 91	1	891,00**
		800 mm	6 008 91	1	981,00**
		900 mm	6 009 91	1	1062,00**
		1000 mm	6 010 91	1	1143,00**
		1200 mm	6 012 91	1	1242,00**
		1500 mm	6 015 91	1	1341,00**
	szkło czarne	700 mm	6 007 92	1	891,00**
		800 mm	6 008 92	1	981,00**
		900 mm	6 009 92	1	1062,00**
1000 mm		6 010 92	1	1143,00**	
1200 mm		6 012 92	1	1242,00**	
1500 mm		6 015 92	1	1341,00**	
 „basic”	polysk	700 mm	6 007 10	1	190,00
		800 mm	6 008 10	1	250,00
		900 mm	6 009 10	1	306,00
		1000 mm	6 010 10	1	350,00
		1200 mm	6 012 10	1	390,00
		1500 mm	6 015 10	1	490,00**
	mat	700 mm	6 007 11	1	230,00
		800 mm	6 008 11	1	295,00
		900 mm	6 009 11	1	345,00
		1000 mm	6 010 11	1	385,00
		1200 mm	6 012 11	1	440,00
		1500 mm	6 015 11	1	550,00**

**) Wylącznie na specjalne zamówienie

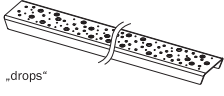
OZ - Opakowanie zbiorcze
Ceny netto (bez VAT).

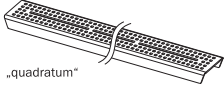
 <p>„lines”</p>	Ruszt prosty „lines”	polysk	Rozmiar	Nr kat.	OZ/szt.	ZŁ/szt.
			700 mm	6 007 20	1	388,00
			800 mm	6 008 20	1	398,00
			900 mm	6 009 20	1	438,00
			1000 mm	6 010 20	1	520,00
			1200 mm	6 012 20	1	602,00
	mat	1500 mm	6 015 20	1	765,00**	
		700 mm	6 007 21	1	470,00	
		800 mm	6 008 21	1	479,00	
		900 mm	6 009 21	1	530,00	
		1000 mm	6 010 21	1	622,00	
		1200 mm	6 012 21	1	725,00	
		1500 mm	6 015 21	1	938,00**	
 <p>„drops”</p>	Ruszt prosty „drops”	polysk	Rozmiar	Nr kat.	OZ/szt.	ZŁ/szt.
			700 mm	6 007 30	1	367,00
			800 mm	6 008 30	1	388,00
			900 mm	6 009 30	1	398,00
			1000 mm	6 010 30	1	470,00
			1200 mm	6 012 30	1	561,00
	mat	1500 mm	6 015 30	1	725,00**	
		700 mm	6 007 31	1	449,00	
		800 mm	6 008 31	1	470,00	
		900 mm	6 009 31	1	479,00	
		1000 mm	6 010 31	1	571,00	
		1200 mm	6 012 31	1	683,00	
		1500 mm	6 015 31	1	867,00**	
 <p>„royal”</p>	Ruszt prosty „royal”	polysk	Rozmiar	Nr kat.	OZ/szt.	ZŁ/szt.
			700 mm	6 007 40	1	499,00
			800 mm	6 008 40	1	530,00
			900 mm	6 009 40	1	561,00
			1000 mm	6 010 40	1	643,00
			1200 mm	6 012 40	1	765,00
	mat	1500 mm	6 015 40	1	969,00**	
		700 mm	6 007 41	1	622,00	
		800 mm	6 008 41	1	643,00	
		900 mm	6 009 41	1	683,00	
		1000 mm	6 010 41	1	765,00	
		1200 mm	6 012 41	1	938,00	
		1500 mm	6 015 41	1	1180,00**	
 <p>„quadratum”</p>	Ruszt prosty „quadratum”	polysk	Rozmiar	Nr kat.	OZ/szt.	ZŁ/szt.
			700 mm	6 007 50	1	499,00
			800 mm	6 008 50	1	530,00
			900 mm	6 009 50	1	561,00
			1000 mm	6 010 50	1	643,00
			1200 mm	6 012 50	1	765,00
	mat	1500 mm	6 015 50	1	969,00**	
		700 mm	6 007 51	1	622,00	
		800 mm	6 008 51	1	643,00	
		900 mm	6 009 51	1	683,00	
		1000 mm	6 010 51	1	765,00	
		1200 mm	6 012 51	1	938,00	
		1500 mm	6 015 51	1	1180,00**	

**) Wyłącznie na specjalne zamówienie

OZ - Opakowanie zbiorcze
Ceny netto (bez VAT).

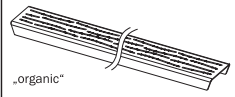
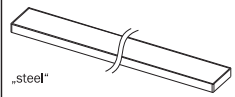
 „organic”	Ruszt prosty „organic”	Rozmiar		Nr kat.	OZ/szt.	Zł./szt.
	polysk	700 mm		6 007 60	1	388,00
		800 mm		6 008 60	1	398,00
		900 mm		6 009 60	1	438,00
		1000 mm		6 010 60	1	520,00
		1200 mm		6 012 60	1	602,00
		1500 mm		6 015 60	1	765,00**
	mat	700 mm		6 007 61	1	469,00
		800 mm		6 008 61	1	479,00
		900 mm		6 009 61	1	530,00
		1000 mm		6 010 61	1	622,00
		1200 mm		6 012 61	1	725,00
		1500 mm		6 015 61	1	938,00**
 „steel”	Ruszt prosty „steel” polysk	Rozmiar		Nr kat.	OZ/szt.	Zł./szt.
	polysk	700 mm		6 007 80	1	450,00
		800 mm		6 008 80	1	495,00
		900 mm		6 009 80	1	570,00
		1000 mm		6 010 80	1	630,00
		1200 mm		6 012 80	1	740,00
		1500 mm		6 015 80	1	940,00**

Ruszt kątowy

OZ - Opakowanie zbiorcze
Ceny netto (bez VAT).

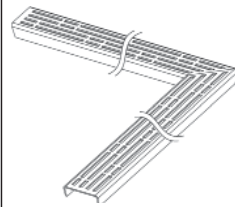
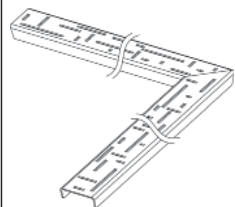
 „basic”	Ruszt kątowy „basic”	Rozmiar		Nr kat.	OZ/szt.	Zł./szt.		
	polysk	900 mm		6 109 10	1	530,00**		
		1000 mm		6 110 10	1	602,00**		
		1200 mm		6 112 10	1	725,00**		
		1500 mm		6 115 10	1	908,00**		
		mat	900 mm		6 109 11	1	643,00 ☐	
			1000 mm		6 110 11	1	725,00 ☐	
	1200 mm			6 112 11	1	867,00 ☐		
	1500 mm			6 115 11	1	1095,00 ☐		
	 „lines”		Ruszt kątowy „lines”	Rozmiar		Nr kat.	OZ/szt.	Zł./szt.
		polysk	900 mm		6 109 20	1	826,00**	
			1000 mm		6 110 20	1	938,00**	
1200 mm				6 112 20	1	1100,00**		
1500 mm				6 115 20	1	1345,00**		
mat			900 mm		6 109 21	1	989,00 ☐	
			1000 mm		6 110 21	1	1110,00 ☐	
	1200 mm		6 112 21	1	1315,00 ☐			
	1500 mm		6 115 21	1	1620,00 ☐			

☐ - Wyprzedaż do wyczerpania zapasów

**) Wyłącznie na specjalne zamówienie

OZ - Opakowanie zbiorcze
Ceny netto (bez VAT).

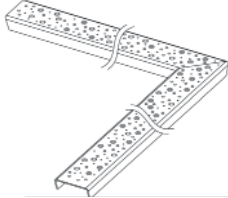
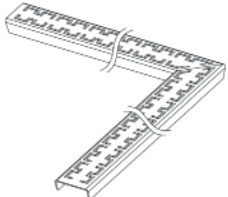
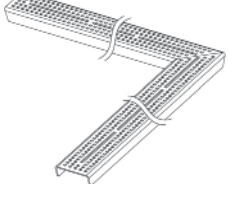
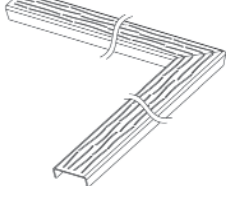
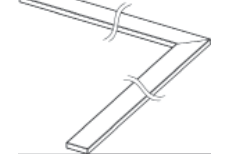
	Ruszt kątowy „drops”	polysk	Rozmiar	Nr kat.	OZ/szt.	Zł/szt.
			900 mm	6 109 30	1	785,00**
			1000 mm	6 110 30	1	887,00**
			1200 mm	6 112 30	1	1060,00**
	mat	900 mm	6 109 31	1	948,00 ☐	
		1000 mm	6 110 31	1	1070,00 ☐	
		1200 mm	6 112 31	1	1285,00 ☐	
		1500 mm	6 115 31	1	1580,00 ☐	
	Ruszt kątowy „royal”	polysk	Rozmiar	Nr kat.	OZ/szt.	Zł/szt.
			900 mm	6 109 40	1	1070,00**
			1000 mm	6 110 40	1	1183,00**
			1200 mm	6 112 40	1	1387,00**
	mat	900 mm	6 109 41	1	1285,00 ☐	
		1000 mm	6 110 41	1	1418,00 ☐	
		1200 mm	6 112 41	1	1682,00 ☐	
		1500 mm	6 115 41	1	2030,00 ☐	
	Ruszt kątowy „quadratum”	polysk	Rozmiar	Nr kat.	OZ/szt.	Zł/szt.
			900 mm	6 109 50	1	1070,00**
			1000 mm	6 110 50	1	1183,00**
			1200 mm	6 112 50	1	1387,00**
	mat	900 mm	6 109 51	1	1285,00 ☐	
		1000 mm	6 110 51	1	1418,00 ☐	
		1200 mm	6 112 51	1	1682,00 ☐	
		1500 mm	6 115 51	1	2030,00 ☐	
	Ruszt kątowy „organic”	polysk	Rozmiar	Nr kat.	OZ/szt.	Zł/szt.
			900 mm	6 109 60	1	826,00**
			1000 mm	6 110 60	1	938,00**
			1200 mm	6 112 60	1	1100,00**
	mat	900 mm	6 109 61	1	989,00 ☐	
		1000 mm	6 110 61	1	1110,00 ☐	
		1200 mm	6 112 61	1	1315,00 ☐	
		1500 mm	6 115 61	1	1620,00 ☐	
	Ruszt kątowy „steel”	polysk	Rozmiar	Nr kat.	OZ/szt.	Zł/szt.
			900 mm	6 109 80	1	1070,00**
			1000 mm	6 110 80	1	1180,00**
			1200 mm	6 112 80	1	1390,00**
			1500 mm	6 115 80	1	1730,00**

☐ - Wypzedaż do wyczerpania zapasów

** Wyłącznie na specjalne zamówienie

Ruszt kątowy i prosty „plate”

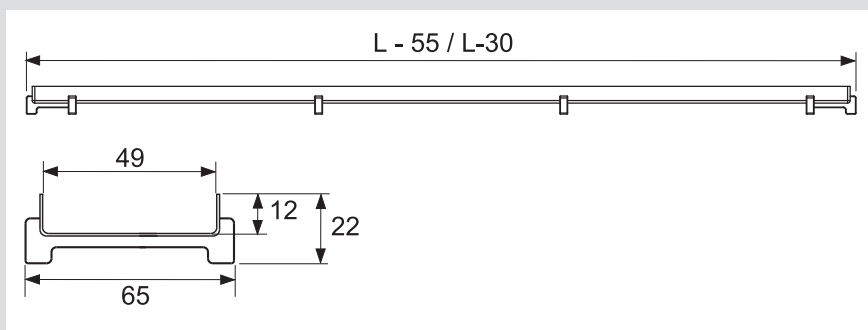

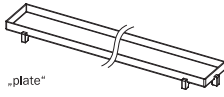
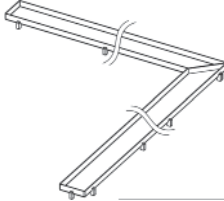

OZ - Opakowanie zbiorcze
Ceny netto (bez VAT).

 <p>„plate”</p>	Ruszt prosty „plate” polysk	Rozmiar	Nr kat.	OZ/szt.	Zł./szt.
		700 mm	6 007 70	1	195,00
		800 mm	6 008 70	1	290,00
		900 mm	6 009 70	1	340,00
		1000 mm	6 010 70	1	390,00
		1200 mm	6 012 70	1	480,00
1500 mm	6 015 70	1	580,00**		
	Ruszt kątowy „plate” polysk	Rozmiar	Nr kat.	OZ/szt.	Zł./szt.
		900 mm	6 109 70	1	805,00**
		1000 mm	6 110 70	1	887,00**
		1200 mm	6 112 70	1	1060,00**
		1500 mm	6 115 70	1	1325,00**



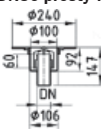

Odpiływy

OZ - Opakowanie zbiorcze
Ceny netto (bez VAT).



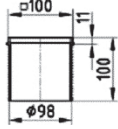

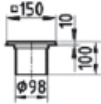
Odpiływy podłogowy TECEdrain – niska zabudowa DN50 kątowy wydajność 0,9 l/s	Nr kat.	OZ/szt.	Zł./szt.
 	3 011 008	1	65,80
Odpiływy podłogowy TECEdrain – DN50 prosty wydajność 0,9 l/s	Nr kat.	OZ/szt.	Zł./szt.
 	3 011 006	1	65,80

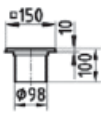
**) Wyłącznie na specjalne zamówienie

Nasadki

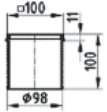
<p>100 mm, ramka z tworzywa</p>  	<p>Nr kat. 3 090 058</p>	<p>OZ/szt. 1</p>	<p>Zł/szt. 38,00</p>
<p>150 mm, ramka z tworzywa</p>  	<p>Nr kat. 3 111 028</p>	<p>OZ/szt. 1</p>	<p>Zł/szt. 38,00</p>
<p>150 mm, ramka ze stali nierdzewnej</p>  	<p>Nr kat. 3 111 030</p>	<p>OZ/szt. 1</p>	<p>Zł/szt. 193,00</p>

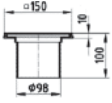
Nasadki z rusztem

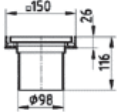
<p>100 mm z rusztem „basic”</p>  	<p>Nr kat. 3 111 000</p>	<p>OZ/szt. 1</p>	<p>Zł/szt. 89,90</p>
<p>150 mm z rusztem „basic”</p>  	<p>Nr kat. 3 111 009</p>	<p>OZ/szt. 1</p>	<p>Zł/szt. 119,90</p>
<p>150 mm z rusztem „plate”</p>  	<p>Nr kat. 3 112 008</p>	<p>OZ/szt. 1</p>	<p>Zł/szt. 299,00</p>

Kratki dekoracyjne



OZ - Opakowanie zbiorcze
Ceny netto (bez VAT).

Kratki dekoracyjne 100 mm	Typ	Nr kat.	OZ/szt.	Zł./szt.
	quadratum	3 100 000	1	269,00 [¤]
drops	3 100 001	1	269,00 [¤]	
royal	3 100 002	1	269,00 [¤]	
rings	3 100 003	1	269,00 [¤]	



OZ - Opakowanie zbiorcze
Ceny netto (bez VAT).

Kratki dekoracyjne 150 mm	Typ	Nr kat.	OZ/szt.	Zł./szt.
	quadratum	3 100 004	1	299,00 [¤]
diagonal	3 100 005	1	299,00 [¤]	
drops	3 100 006	1	299,00 [¤]	
rings	3 100 007	1	299,00 [¤]	



OZ - Opakowanie zbiorcze
Ceny netto (bez VAT).

Kratki dekoracyjne 150 mm	Typ	Nr kat.	OZ/szt.	Zł./szt.
	royal 2	3100008	1	299,00 [¤]
royal 1	3100009	1	299,00 [¤]	
various	3100010	1	299,00 [¤]	
organic	3100011	1	299,00 [¤]	



OZ - Opakowanie zbiorcze
Ceny netto (bez VAT).

Kratki dekoracyjne 150 mm	Typ	Nr kat.	OZ/szt.	Zł./szt.
	smiley	3 100 026	1	299,00 [¤]
windmill	3 100 027	1	299,00 [¤]	
fish	3 100 028	1	299,00 [¤]	
creative	3 100 029	1	299,00 [¤]	

¤ - Wypzedaż do wyczerpania zapasów

Dyrektor Handlowy – Cezary Hałas tel. 601 561 746

TECE 1: Szef Regionu – Piotr Blige – tel. 691 015 350

Doradca ds. Technicznych i Projektowych – Aleksander Podzorski	–	tel. 665 855 552
Doradca Techniczno-Handlowy – Hubert Marzyński (region zachodniopomorski)	–	tel. 693 699 900
Doradca Techniczno-Handlowy – Marcin Malmyga (region lubuski)	–	tel. 697 588 883
Doradca Techniczno-Handlowy – Paweł Wawrzyniak (region wielkopolski-północny)	–	tel. 697 588 887
Doradca Techniczno-Handlowy – Krzysztof Gawroński (region wielkopolski-południowy)	–	tel. 503 143 056
Doradca Techniczno-Handlowy – Paweł Pogódek (region łódzki)	–	tel. 535 366 006

TECE 2: Szef Regionu – Rafał Petryszyn – tel. 693 599 990

Doradca Techniczno-Handlowy – Adam Dondalski (region warmińsko-mazurski)	–	tel. 515 061 236
Doradca Techniczno-Handlowy – Andrzej Lewandowski (region kujawsko-pomorski)	–	tel. 601 942 489
Doradca Techniczno-Handlowy – Łukasz Paszkowski (region pomorski)	–	tel. 601 640 725

TECE 3: Szef Regionu – Paweł Sierpień – tel. 609 614 274

Doradca ds. Technicznych i Projektowych – Piotr Tymowski	–	tel. 691 994 443
Doradca Techniczno-Handlowy – Tomasz Miaskiewicz (region mazowiecki)	–	tel. 519 539 100
Doradca Techniczno-Handlowy – Grzegorz Łopieński (region podlaski)	–	tel. 691 976 576
Doradca Techniczno-Handlowy – Tomasz Kowalczyk (region lubelski)	–	tel. 665 855 557

TECE 4: Szef Regionu – Grzegorz Koźmiński – tel. 601 874 881

Doradca Techniczno-Handlowy – Józef Bodak (region dolnośląski)	–	tel. 515 061 235
Doradca Techniczno-Handlowy – Krzysztof Kozarewicz (region opolski)	–	tel. 665 955 585
Doradca ds. Technicznych i Projektowych – Maciej Bobusia	–	tel. 535 393 644

TECE 5: Szef Regionu – Rafał Durda – tel. 603 982 247

Doradca ds. Technicznych i Projektowych – Piotr Witczak	–	tel. 518 018 551
Doradca Techniczno-Handlowy – Paweł Gębala (region małopolski)	–	tel. 504 145 528
Doradca Techniczno-Handlowy – Wojciech Godula (Region śląski)	–	tel. 605 789 864
Doradca Techniczno-Handlowy – Adam Filipiuk (region podkarpacki, świętokrzyski)	–	tel. 609 366 688

Doradztwo Techniczno-Projektowe:

Dyrektor ds. Technicznych – Andrzej Durda	–	tel. 71 38 39 104 601 756 628
Doradca ds. Technicznych i Projektowych – Andrzej Marchewicz	–	tel. 601 940 056
Doradca ds. Technicznych – Krzysztof Kaczmarek	–	tel. 71 38 39 105 503 188 812
Doradca ds. Technicznych – Andrzej Majewski	–	tel. 71 38 39 106 601 781 474

Szef Serwisu

Mirosław Litke, tel. 71 38 39 132, 506 055 898

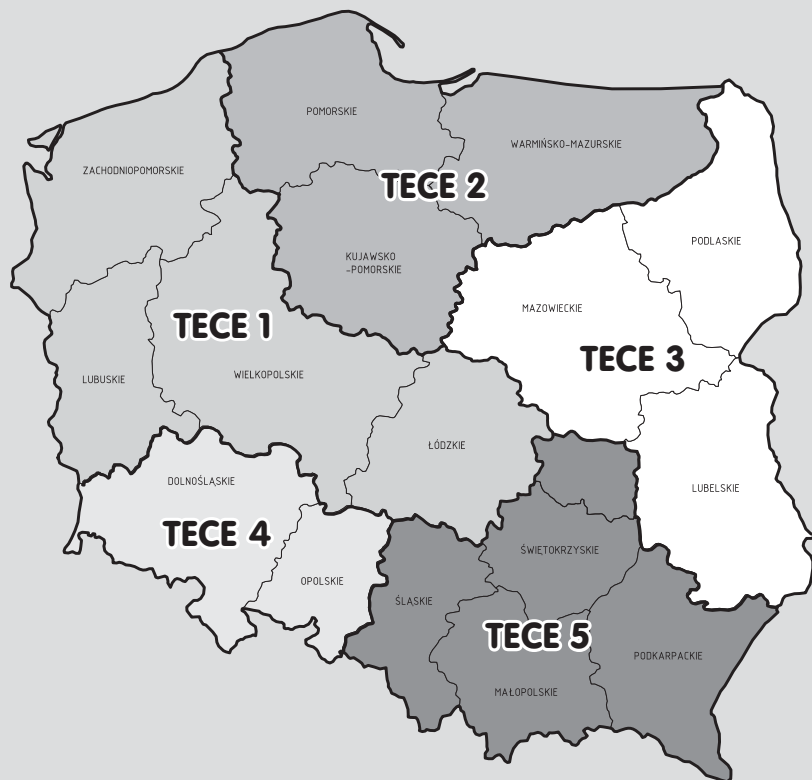

Cennik obowiązuje od 1 lipca 2011r. do następnej edycji.

TECE Sp. z o.o. nie ponosi odpowiedzialności za błędy edytorskie bądź drukarskie, które mogły znaleźć się w cenniku.

TECE Sp. z o.o. zastrzega sobie prawo do zmiany cen.

TECE

Inteligentna technika domowa

TECE Sp. z o.o.

57-100 Strzelin • ul. Wrocławska 61

Centrala 71 38 39 100

Logistyka 71 38 39 114, -115, -116

Fax 71 38 39 101

e-mail: tece@tece.pl • <http://www.tece.pl>

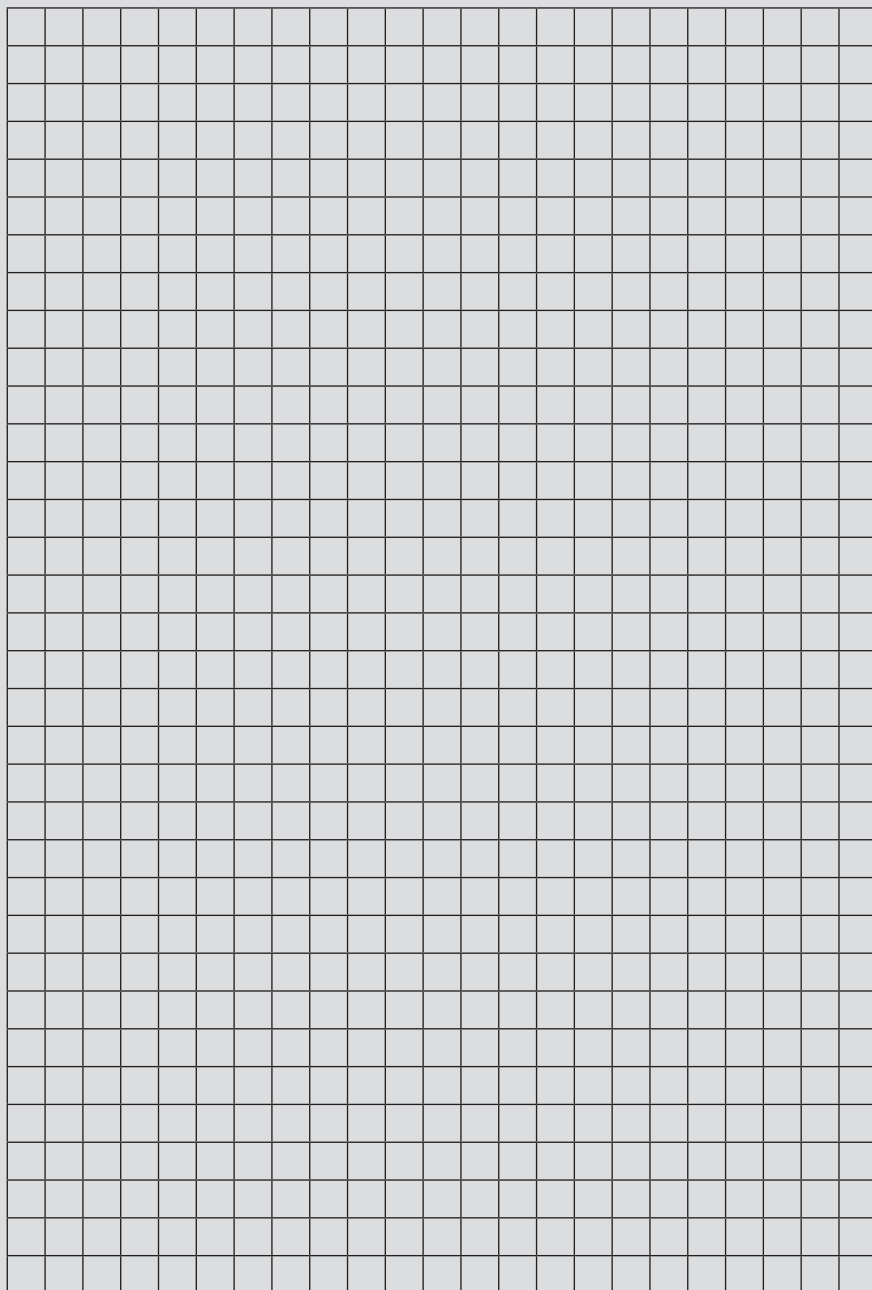

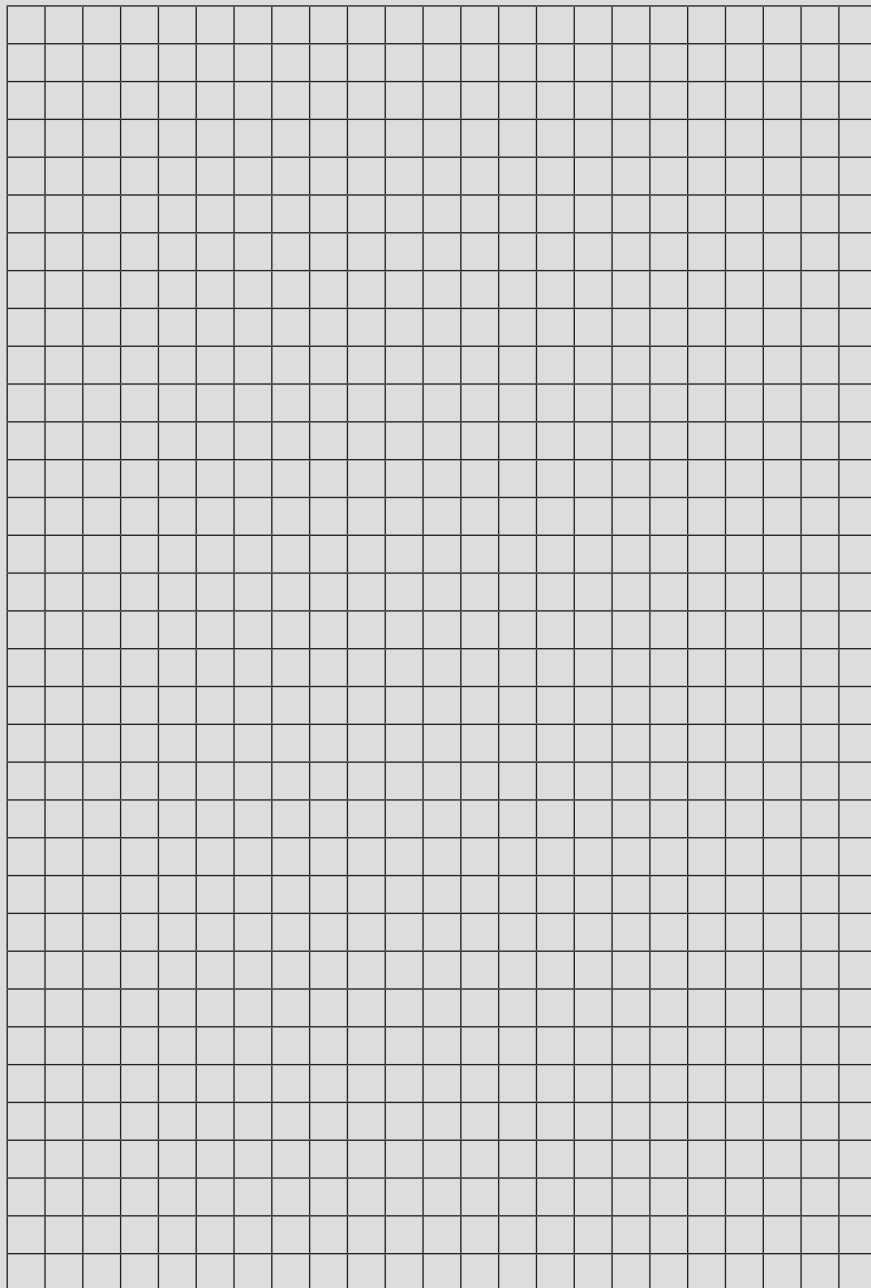

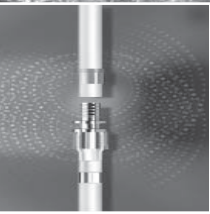

TECEflex®

Uniwersalny system instalacji wodnych i grzewczych

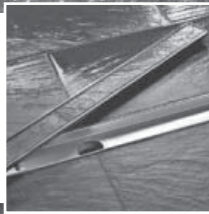

TECEdrainline® **TECEdrain®**

Odwodnienia liniowe i punktowe



TECEflex®

Wodne ogrzewanie podłogowe



TECEprofil®

System podtynkowy do renowacji i nowych obiektów

TECE sp. z o.o.

57-100 Strzelin

ul. Wrocławska 61

Centrala 71 38 39 100

Logistyka 71 38 39 114, 71 38 39 115

71 38 39 116

Fax 71 38 39 101

e-mail: tece@tece.pl, <http://www.tece.pl>

TECE.

Inteligentna technika domowa